



ML150 Standing Seam

Master Details

Architectural / Solid Substrate / Steep Slope

- Plywood Substrate -

The following details are sample details commonly used over steep sloped applications including those over solid substrates such as plywood or steel decking with rigid insulation. Such details are largely based on hydrokinetic (water shedding) design principles and architectural detailing.



Thermal Gap Installation Chart.....	ML150-INFO-1.00
Extended Eave.....	ML150-PS-1.00
Extended Eave with Gutter.....	ML150-PS-1.10
Gable Detail - Extended Drip Style.....	ML150-PS-2.10
Gable Detail - Box Style.....	ML150-PS-2.30
Valley Detail - Integral Cleat.....	ML150-PS-3.10
Valley Lap Detail.....	ML150-PS-3.10a
Valley - with Offset Cleat.....	ML150-PS-3.20
Hip and Ridge Detail.....	ML150-PS-4.10
Vented Ridge Detail.....	ML150-PS-4.40
Peak Detail.....	ML150-PS-5.10
Peak Detail - with Wall Panels.....	ML150-PS-5.40
Headwall Detail - Reglet.....	ML150-PS-6.11
Headwall Detail - Parapet Coping.....	ML150-PS-6.20
Sidewall Detail - Reglet.....	ML150-PS-7.11
Sidewall Detail - Surface Mount.....	ML150-PS-7.12
Sidewall Detail - Reglet.....	ML150-PS-7.21
Sidewall Detail - Surface Mount.....	ML150-PS-7.22

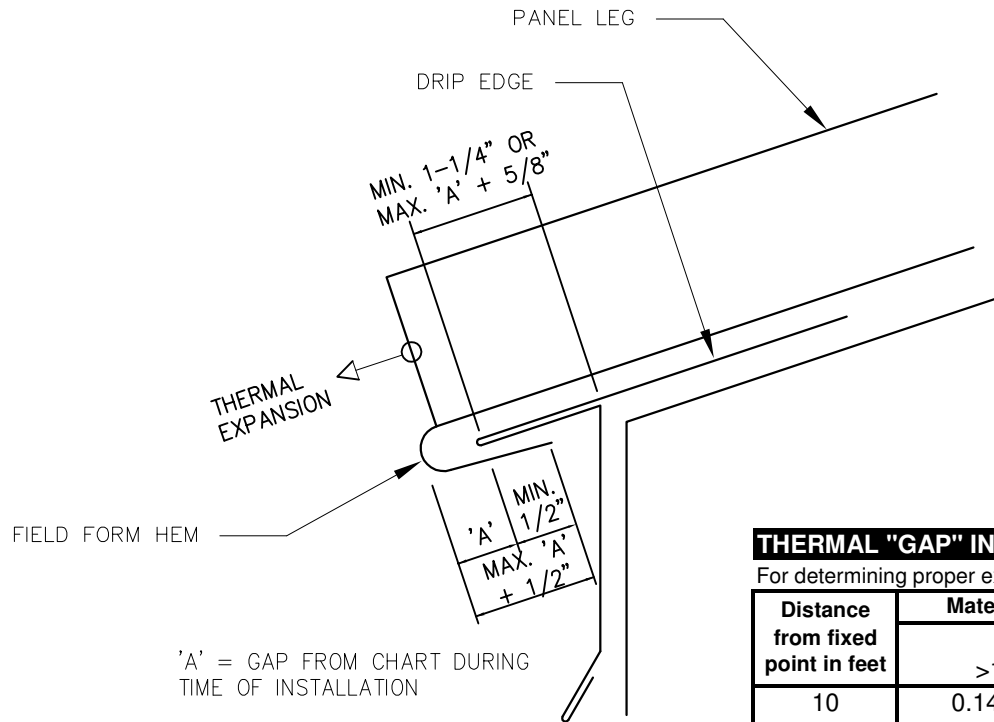

THERMAL "GAP" INSTALLATION CHART (In inches) - STEEL

For determining proper expansion/contraction gap at panel ends during installation

Distance from fixed point in feet	Material Temperature (Surface Temperature) During Installation					
	Hot >100° F		Warm 100° to 50° F		Cold <50° F	
10	0.145	1/8	0.072	1/16	0.000	0
20	0.289	5/16	0.145	1/8	0.000	0
30	0.434	7/16	0.217	3/16	0.125	1/8
40	0.579	9/16	0.289	5/16	0.125	1/8
50	0.724	3/4	0.362	3/8	0.188	3/16
60	0.868	7/8	0.434	7/16	0.188	3/16
70	1.013	1	0.507	1/2	0.250	1/4
80	1.158	1 3/16	0.579	9/16	0.250	1/4
90	1.302	1 5/16	0.651	5/8	0.375	3/8
100	1.447	1 7/16	0.724	3/4	0.375	3/8

* Chart based on temperature differential of: 180 degrees F

* Coefficient of thermal expansion for steel: 0.0000067



Description:

THERMAL GAP INSTALLATION CHART

Detail No.:

ML150-INFO-1.00

Substrate:

GENERAL INFORMATION

Project Name:

Location:

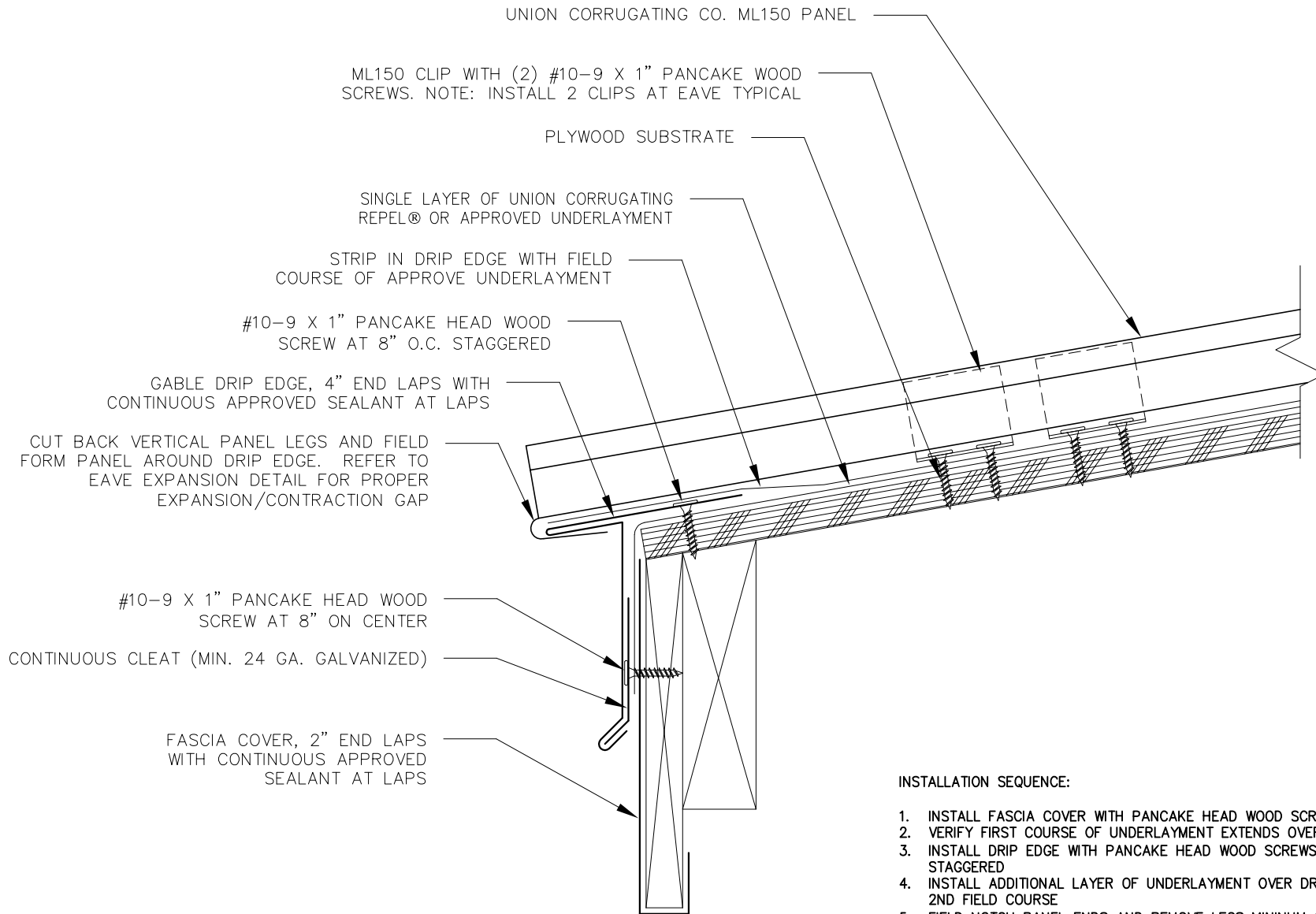

INSTALLATION SEQUENCE:

1. INSTALL FASCIA COVER WITH PANCAKE HEAD WOOD SCREWS AT 12" O.C. MAX.
2. VERIFY FIRST COURSE OF UNDERLAYMENT EXTENDS OVER FASCIA COVER
3. INSTALL DRIP EDGE WITH PANCAKE HEAD WOOD SCREWS AT 8" ON CENTER STAGGERED
4. INSTALL ADDITIONAL LAYER OF UNDERLAYMENT OVER DRIP EDGE AND UNDER 2ND FIELD COURSE
5. FIELD NOTCH PANEL ENDS AND REMOVE LEGS MINIMUM 1". FORM PANEL HEM AND INSTALL. REFER TO PANEL EXPANSION CHART FOR PROPER INSTALLATION GAP AT DRIP EDGE
6. INSTALL 2 PANEL CLIPS AT EAVES TYPICAL (WITHIN 12" OF EAVE) AND CONTINUE INSTALLING CLIPS AT REQUIRED SPACING



Description:

EXTENDED EAVE

Detail No.:

ML150-PS-1.00

Substrate:

PLYWOOD SUBSTRATE

Project Name:

Location:

UNION CORRUGATING CO. ML150 PANEL

ML150 CLIP WITH (2) #10-9 X 1" PANCAKE WOOD SCREWS. NOTE: INSTALL 2 CLIPS AT EAVE TYPICAL

PLYWOOD SUBSTRATE

SINGLE LAYER OF UNION CORRUGATING REPEL® OR APPROVED UNDERLAYMENT

STRIP IN DRIP EDGE WITH FIELD COURSE OF APPROVE UNDERLAYMENT

#10-9 X 1" PANCAKE HEAD WOOD SCREW AT 8" O.C. STAGGERED

EXTENDED DRIP EDGE, 4" END LAPS WITH CONTINUOUS APPROVED SEALANT AT LAPS

CUT BACK VERTICAL PANEL LEGS AND FIELD FORM PANEL AROUND DRIP EDGE. REFER TO EAVE EXPANSION DETAIL FOR PROPER EXPANSION/CONTRACTION GAP

18 GA. GALVANIZED STEEL HIDDEN HANGER AT 24" ON CENTER

GUTTER, LAP AND SEAL CONTINUOUS WITH 2 ROWS OF APPROVED SEALANT. RIVET AT LAPS 2" ON CENTER. FASCIA COVER, 2" END LAPS WITH CONTINUOUS APPROVED SEALANT AT LAPS

INSTALLATION SEQUENCE:

1. INSTALL FASCIA COVER WITH PANCAKE HEAD WOOD SCREWS AT 12" O.C. MAX.
2. INSTALL GUTTER WITH HIDDEN HANGERS AT 24" O.C. MAX.
3. VERIFY FIRST COURSE OF UNDERLAYMENT EXTENDS INTO GUTTER
4. INSTALL DRIP EDGE WITH PANCAKE HEAD WOOD SCREWS AT 8" ON CENTER STAGGERED
5. INSTALL ADDITIONAL LAYER OF UNDERLAYMENT OVER DRIP EDGE AND UNDER 2ND FIELD COURSE
6. FIELD NOTCH PANEL ENDS AND REMOVE LEGS MINIMUM 1". FORM PANEL HEM AND INSTALL. REFER TO PANEL EXPANSION CHART FOR PROPER INSTALLATION GAP AT DRIP EDGE
7. INSTALL 2 PANEL CLIPS AT EAVES TYPICAL (WITHIN 12" OF EAVE) AND CONTINUE INSTALLING CLIPS AT REQUIRED SPACING



Description:

EXTENDED EAVE WITH GUTTER

Detail No.:

ML150-PS-1.10

Substrate:

PLYWOOD SUBSTRATE

Project Name:

Location:

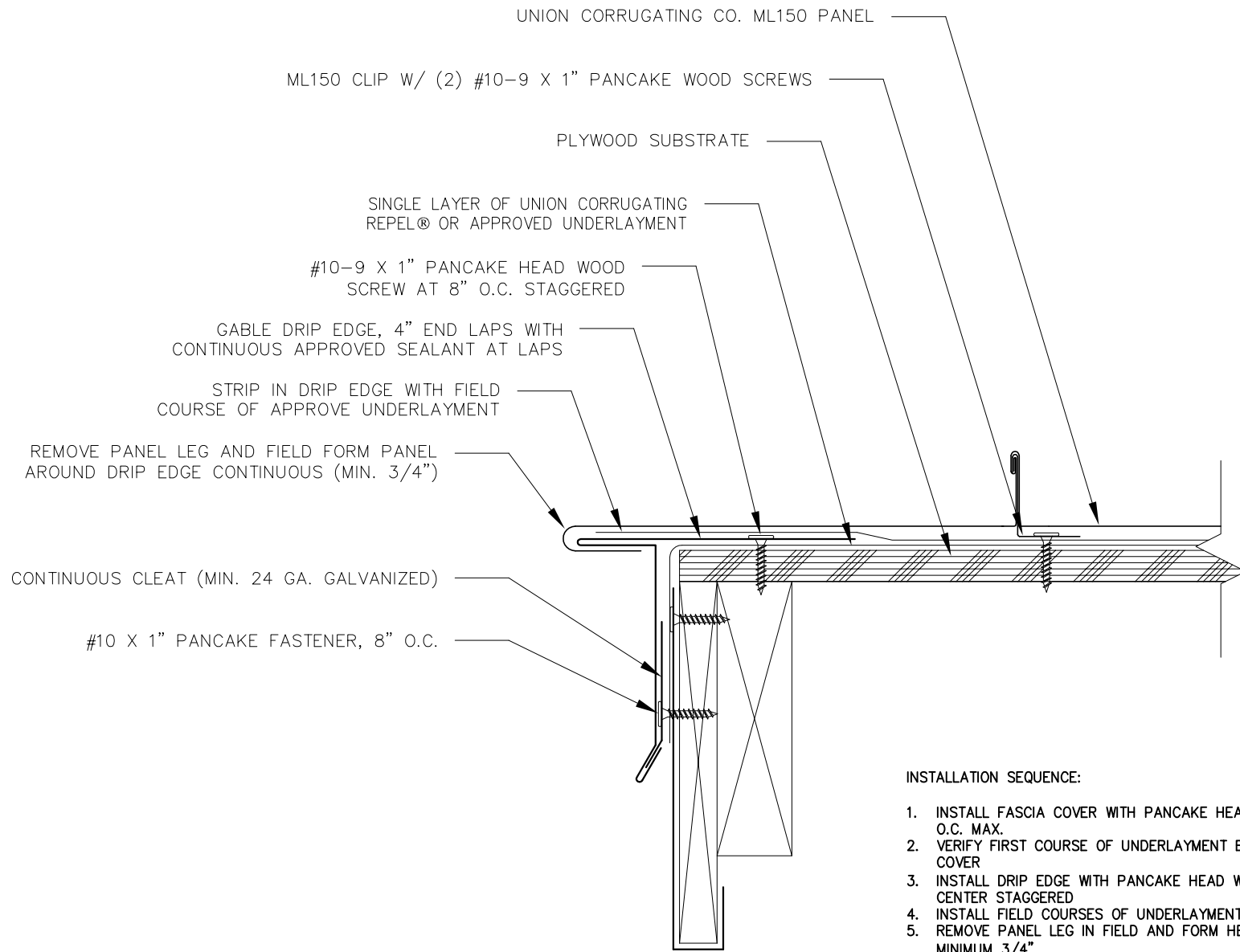

INSTALLATION SEQUENCE:

1. INSTALL FASCIA COVER WITH PANCAKE HEAD WOOD SCREWS AT 12" O.C. MAX.
2. VERIFY FIRST COURSE OF UNDERLAYMENT EXTENDS OVER FASCIA COVER
3. INSTALL DRIP EDGE WITH PANCAKE HEAD WOOD SCREWS AT 8" ON CENTER STAGGERED
4. INSTALL FIELD COURSES OF UNDERLAYMENT OVER DRIP EDGE
5. REMOVE PANEL LEG IN FIELD AND FORM HEM AROUND DRIP EDGE MINIMUM 3/4"
6. INSTALL FIRST PANEL WITH CLIPS AT HALF THE REQUIRED SPACING AS FOR FIELD OF ROOF.



Description:

GABLE DETAIL - EXTENDED DRIP STYLE

Detail No.:

ML150-PS-2.10

Substrate:

PLYWOOD SUBSTRATE

Project Name:

Location:

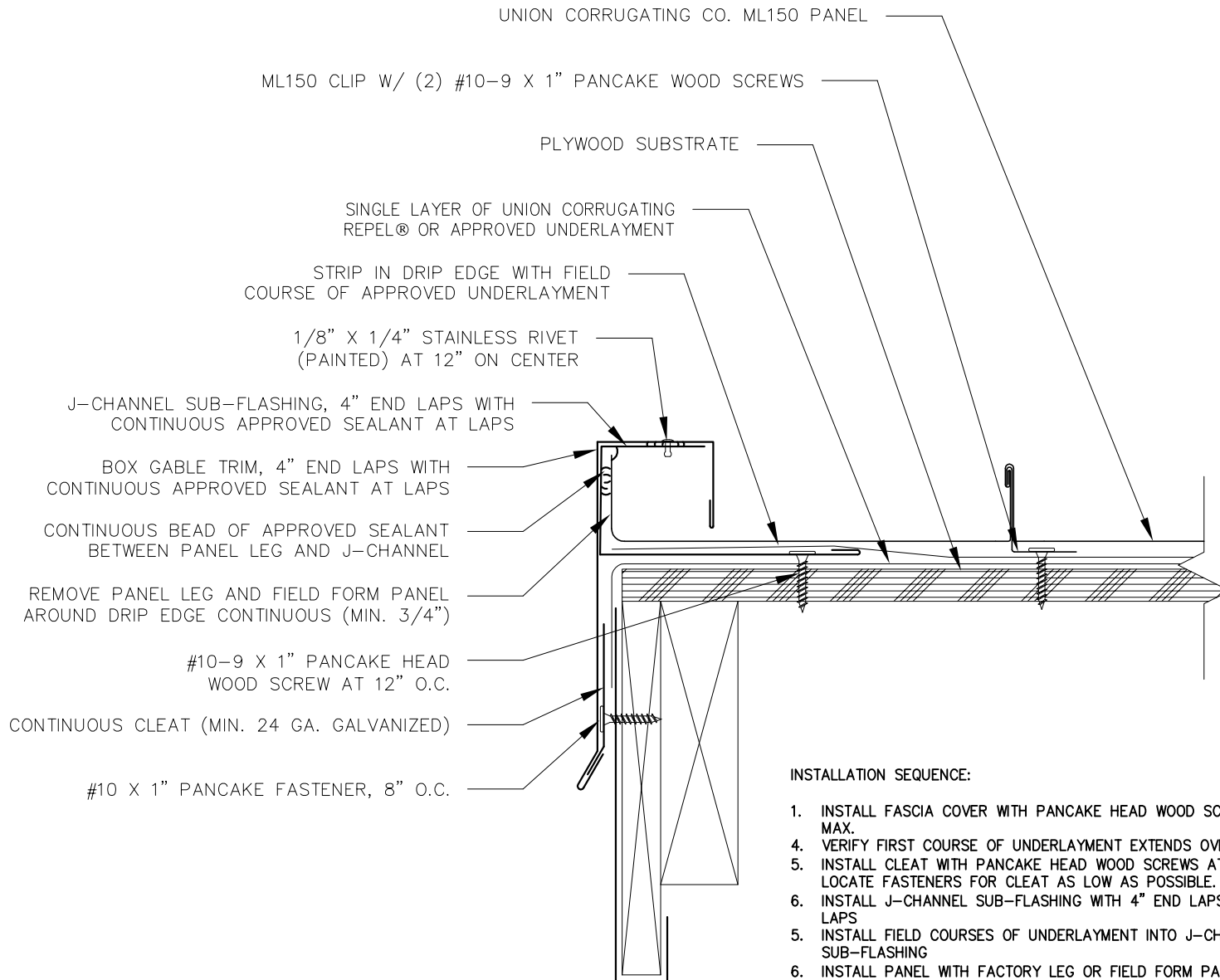

INSTALLATION SEQUENCE:

1. INSTALL FASCIA COVER WITH PANCAKE HEAD WOOD SCREWS AT 12" O.C. MAX.
4. VERIFY FIRST COURSE OF UNDERLAYMENT EXTENDS OVER FASCIA COVER
5. INSTALL CLEAT WITH PANCAKE HEAD WOOD SCREWS AT 8" ON CENTER. LOCATE FASTENERS FOR CLEAT AS LOW AS POSSIBLE.
6. INSTALL J-CHANNEL SUB-FLASHING WITH 4" END LAPS AND SEAL AT LAPS
5. INSTALL FIELD COURSES OF UNDERLAYMENT INTO J-CHANNEL SUB-FLASHING
6. INSTALL PANEL WITH FACTORY LEG OR FIELD FORM PANEL LEG (MIN. 1-1/4" TALL)
7. INSTALL FIRST PANEL WITH CLIPS AT HALF THE REQUIRED SPACING AS FOR FIELD OF ROOF.
8. INSTALL BOX GABLE TRIM WITH 4" END LAPS AND SEAL AT LAPS



Description: **GABLE DETAIL - BOX STYLE**

Substrate: **PLYWOOD SUBSTRATE**

Project Name:

Location:

Detail No.: **ML150-PS-2.30**

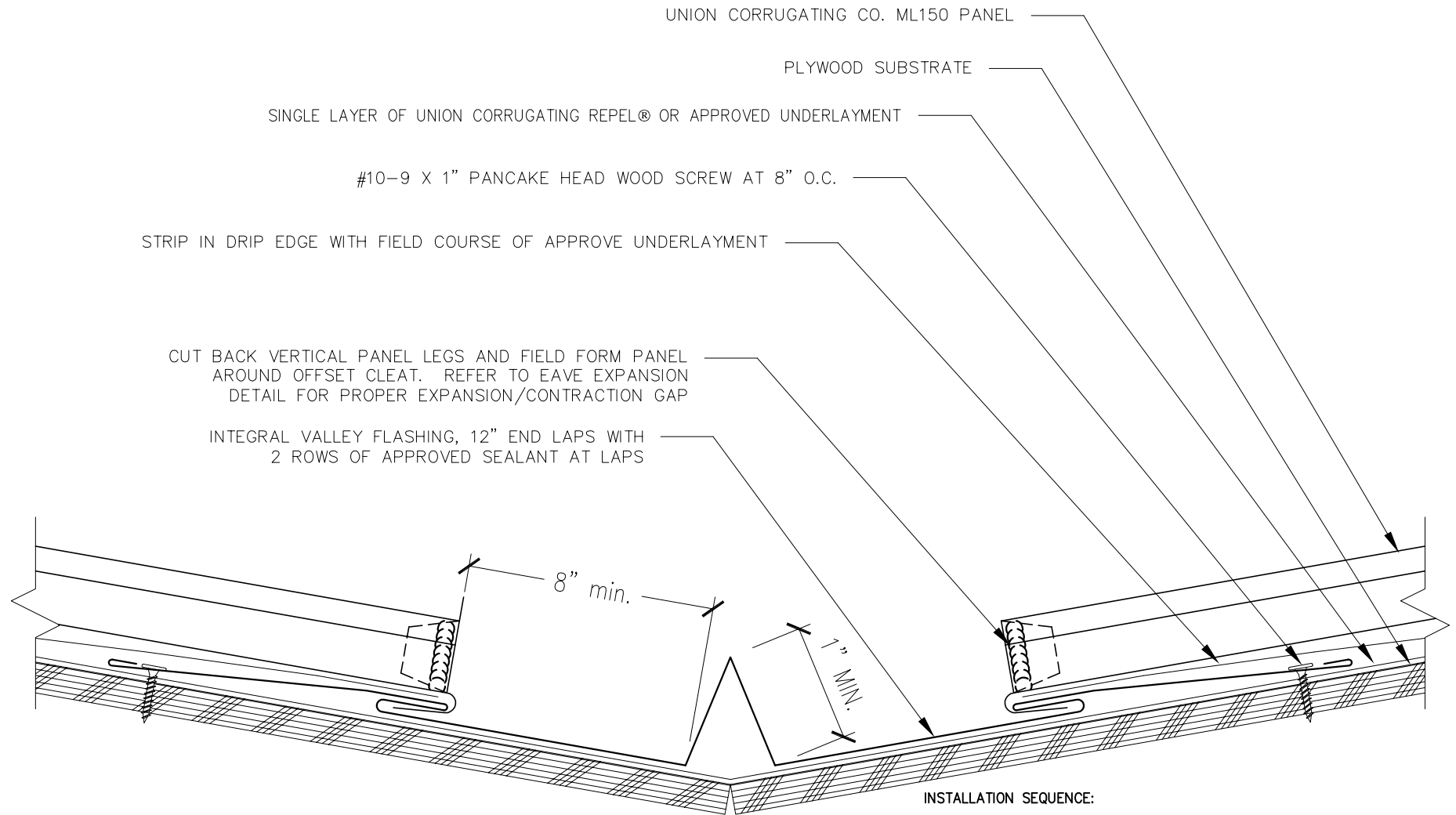

INSTALLATION SEQUENCE:

1. INSTALL VALLEY FLASHING WITH 12" END LAPS AND SEALANT AT LAPS
2. INSTALL FIELD COURSES OF UNDERLAYMENT OVER VALLEY FLASHING TO OFFSET HEM
3. FIELD NOTCH AND HEM PANELS MINIMUM 1" AT ENDS. INSTALL INTO OFFSET HEM OF VALLEY FLASHING. PLACE PANEL CLIPS ABOVE VALLEY FLASHING.
4. APPLY BEAD OF SEALANT IN END OF PANE SEAM AND FOLD TAB OF SEAM AROUND (DOWNSLOPE) TO CLOSE END OF RIB



Description:

VALLEY DETAIL - INTEGRAL CLEAT

Detail No.:

ML150-PS-3.10

Substrate:

PLYWOOD SUBSTRATE

Project Name:

Location:

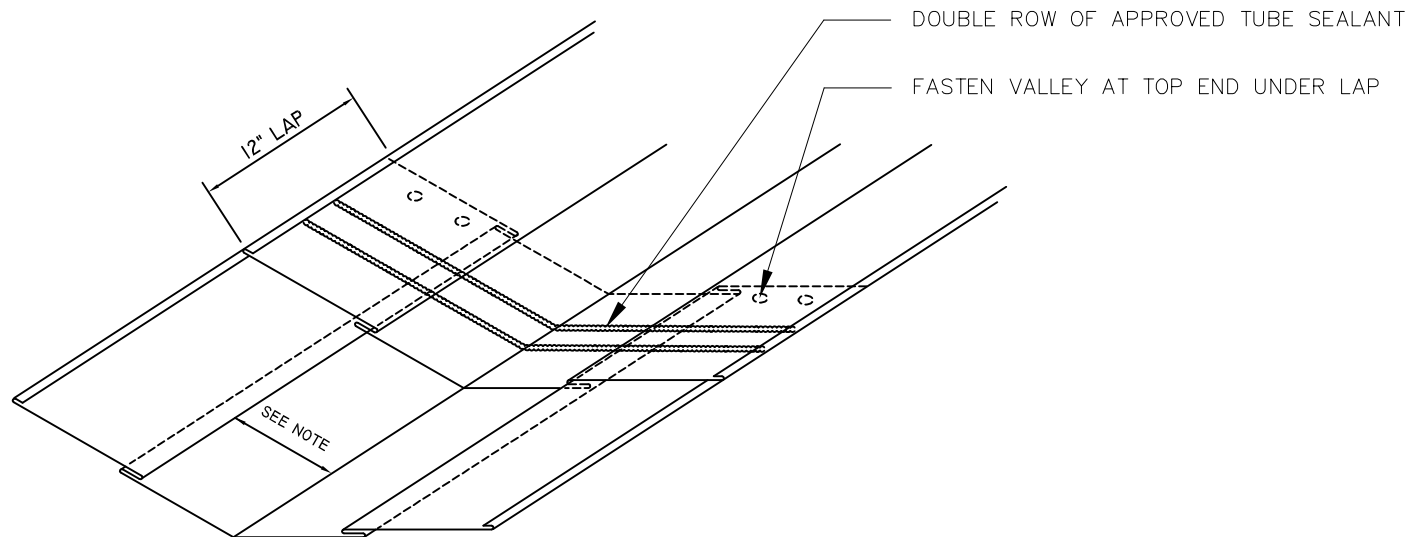

TELESCOPING VALLEY FLASHING LAP

NOTE: EACH VALLEY SECTION IS
MADE PROGRESSIVELY SMALLER
TO ALLOW UPPER SECTION TO
INSERT INTO LOWER SECTION.
NO FIELD NOTCHING AT LAP.



Description:

VALLEY LAP DETAIL

Detail No.:

ML150-PS-3.10a

Substrate:

PLYWOOD SUBSTRATE

Project Name:

Location:

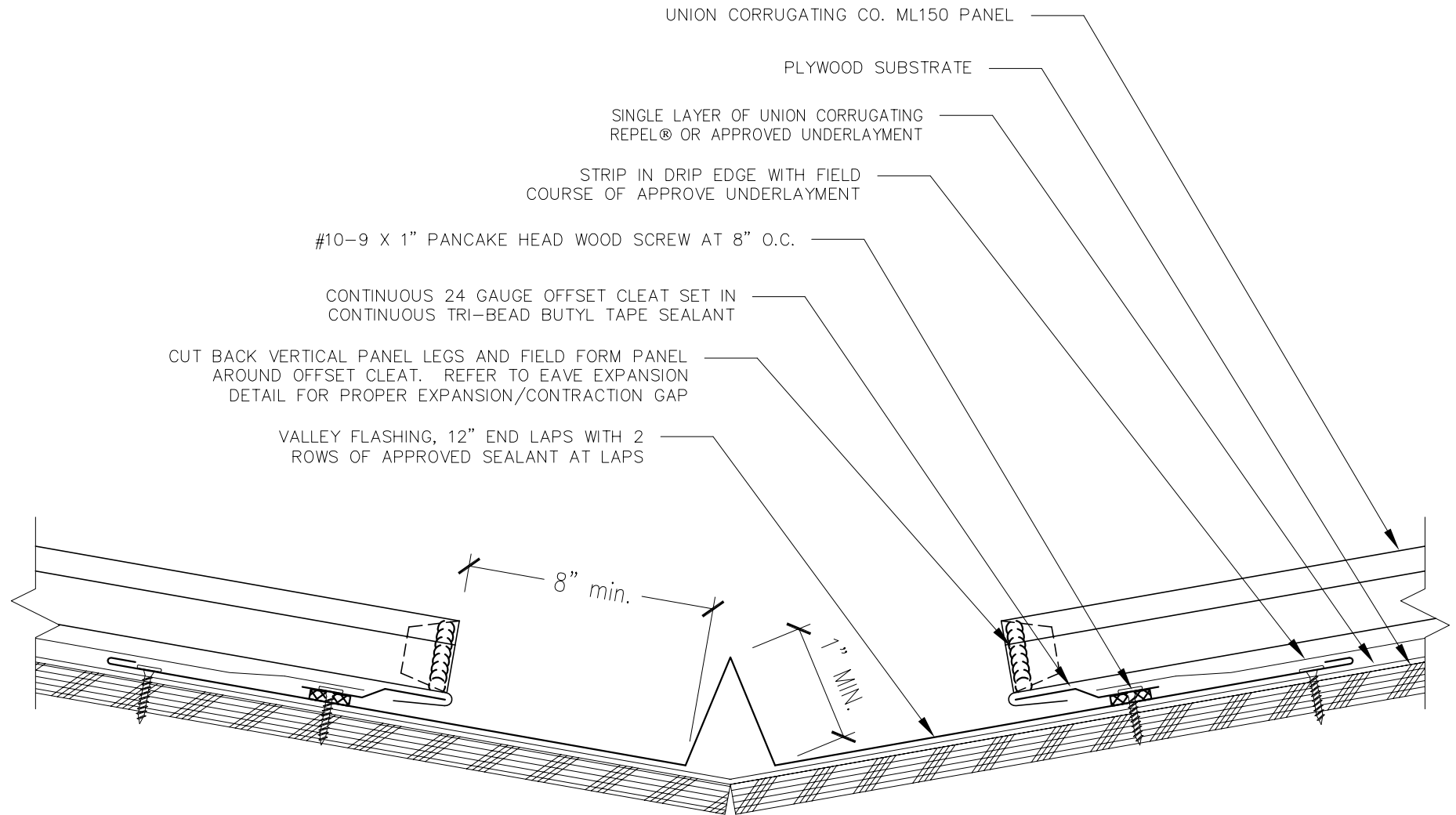

INSTALLATION SEQUENCE:

1. INSTALL VALLEY FLASHING WITH 12" END LAPS AND SEALANT AT LAPS
2. INSTALL CONTINUOUS OFFSET CLEAT 8" MIN. FROM CENTER OF VALLEY, SET IN BEAD OF TAPE
3. INSTALL FIELD COURSES OF UNDERLAYMENT OVER VALLEY FLASHING TO OFFSET HEM
4. FIELD NOTCH AND HEM PANELS MINIMUM 1" AT ENDS. INSTALL INTO OFFSET HEM OF VALLEY FLASHING. PLACE PANEL CLIPS ABOVE VALLEY FLASHING.
5. APPLY BEAD OF SEALANT IN END OF PANE SEAM AND FOLD TAB OF SEAM AROUND (DOWNSLOPE) TO CLOSE END OF RIB



Description:

VALLEY - WITH OFFSET CLEAT

Detail No.:

ML150-PS-3.20

Substrate:

PLYWOOD SUBSTRATE

Project Name:

Location:

1/8" X 1/4" STAINLESS STEEL RIVET (PAINTED) AT 18" ON CENTER

ZEE CLOSURE, FIELD CUT TO FIT BETWEEN PANEL RIBS

CONTINUOUS BEAD OF APPROVED SEALANT ADJACENT TO PANEL RIBS

#10-9 X 1" PANCAKE HEAD WOOD SCREW, INSTALL MIN. 4 PER ZEE OR 3" ON CENTER

TRIPLE BEAD BUTYL TAPE SEALANT CONTINUOUS UNDER ZEE CLOSURE

RIDGE CAP, 4" END LAPS WITH CONTINUOUS APPROVED SEALANT AT LAPS

UNION CORRUGATING CO. ML150 PANEL

SINGLE LAYER OF UNION CORRUGATING
REPEL® OR APPROVED UNDERLAYMENT

PLYWOOD SUBSTRATE

ML150 CLIP W/ (2) #10-9 X 1"
PANCAKE WOOD SCREWS

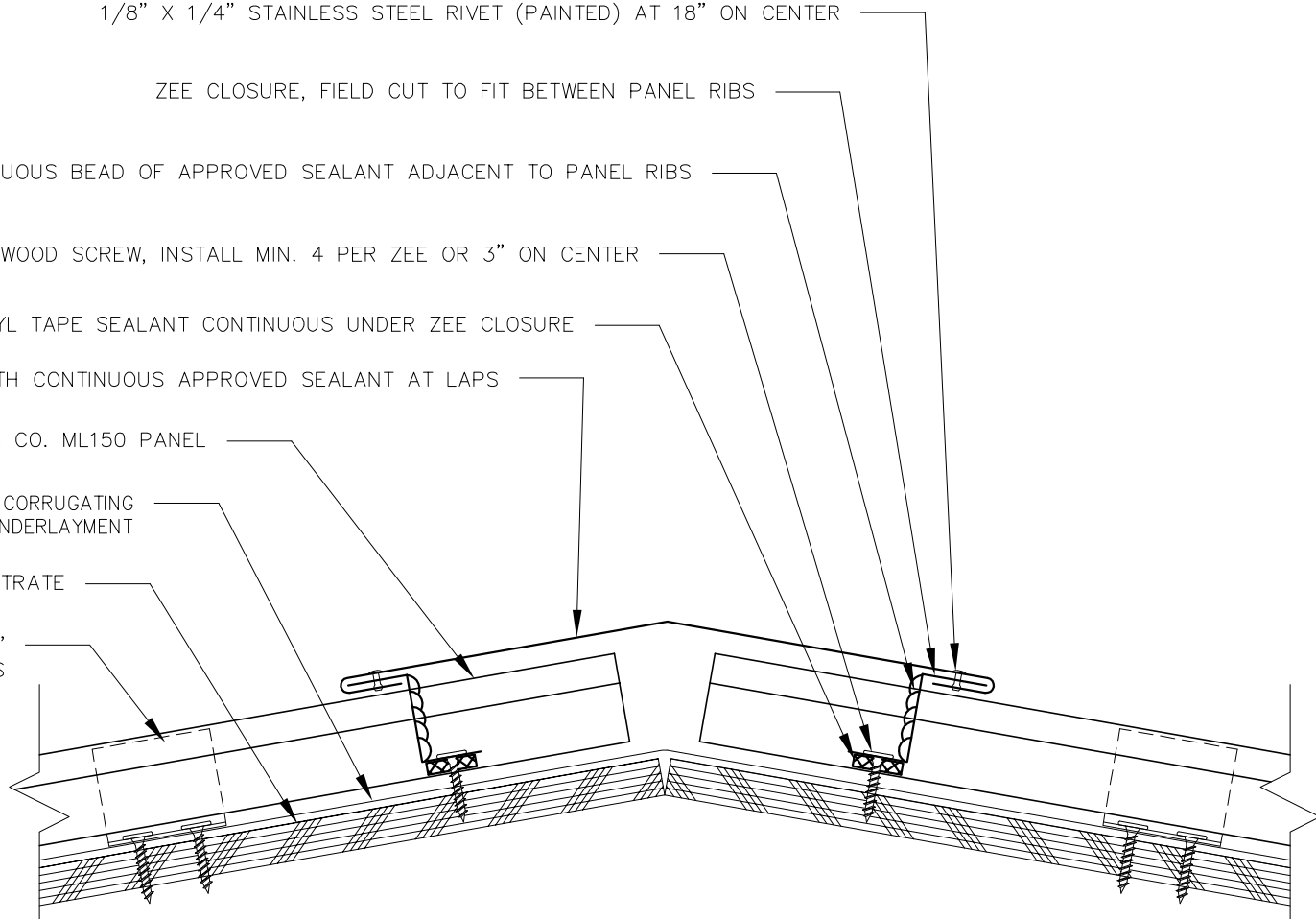

INSTALLATION SEQUENCE:

1. WITH PANELS COMPLETELY INSTALLED OVER SUBSTRATE, LOCATE POSITION OF ZEE CLOSURES AND MARK THE REQUIRED LOCATION
2. FIELD CUT ZEE CLOSURES TO FIT BETWEEN PANEL RIBS AND SET IN CONTINUOUS BEAD OF TAPE SEALANT
3. USE MINIMUM 4 SCREWS PER ZEE CLOSURE OR AT 3" ON CENTER. VERIFY CLOSURE IS FREE OF GAPS OR VOIDS ADJACENT TO PANEL
4. APPLY BEAD OF SEALANT UP EACH SIDE OF ZEE CLOSURE ADJACENT TO PANEL LEGS
5. INSTALL HIP OR RIDGE COVER WITH 4" END LAPS AND SEAL AT LAPS. RIVET CAP TO ZEES AT 18" ON CENTER BOTH SIDES



Description:

HIP AND RIDGE DETAIL

Detail No.:

ML150-PS-4.10

Substrate:

PLYWOOD SUBSTRATE

Project Name:

Location:

1/8" X 1/4" STAINLESS STEEL RIVET (PAINTED) AT 18" ON CENTER

CONTINUOUS BEAD OF APPROVED SEALANT ADJACENT TO PANEL RIBS

#10-9 X 1" PANCAKE HEAD WOOD SCREW, INSTALL MIN. 4 PER ZEE OR 3" ON CENTER

TRIPLE BEAD BUTYL TAPE SEALANT CONTINUOUS UNDER ZEE CLOSURE

VENTED RIDGE CAP, 4" END LAPS WITH CONTINUOUS APPROVED SEALANT AT LAPS

CONTINUOUS 20 GA. GALVANIZED PERFORATED VENT CLEAT

ZEE CLOSURE, FIELD CUT TO FIT BETWEEN PANEL RIBS

UNION CORRUGATING CO. ML150 PANEL

SINGLE LAYER OF UNION CORRUGATING REPEL® OR APPROVED UNDERLAYMENT

PLYWOOD SUBSTRATE

ML150 CLIP W/ (2) #10-9 X 1" PANCAKE WOOD SCREWS

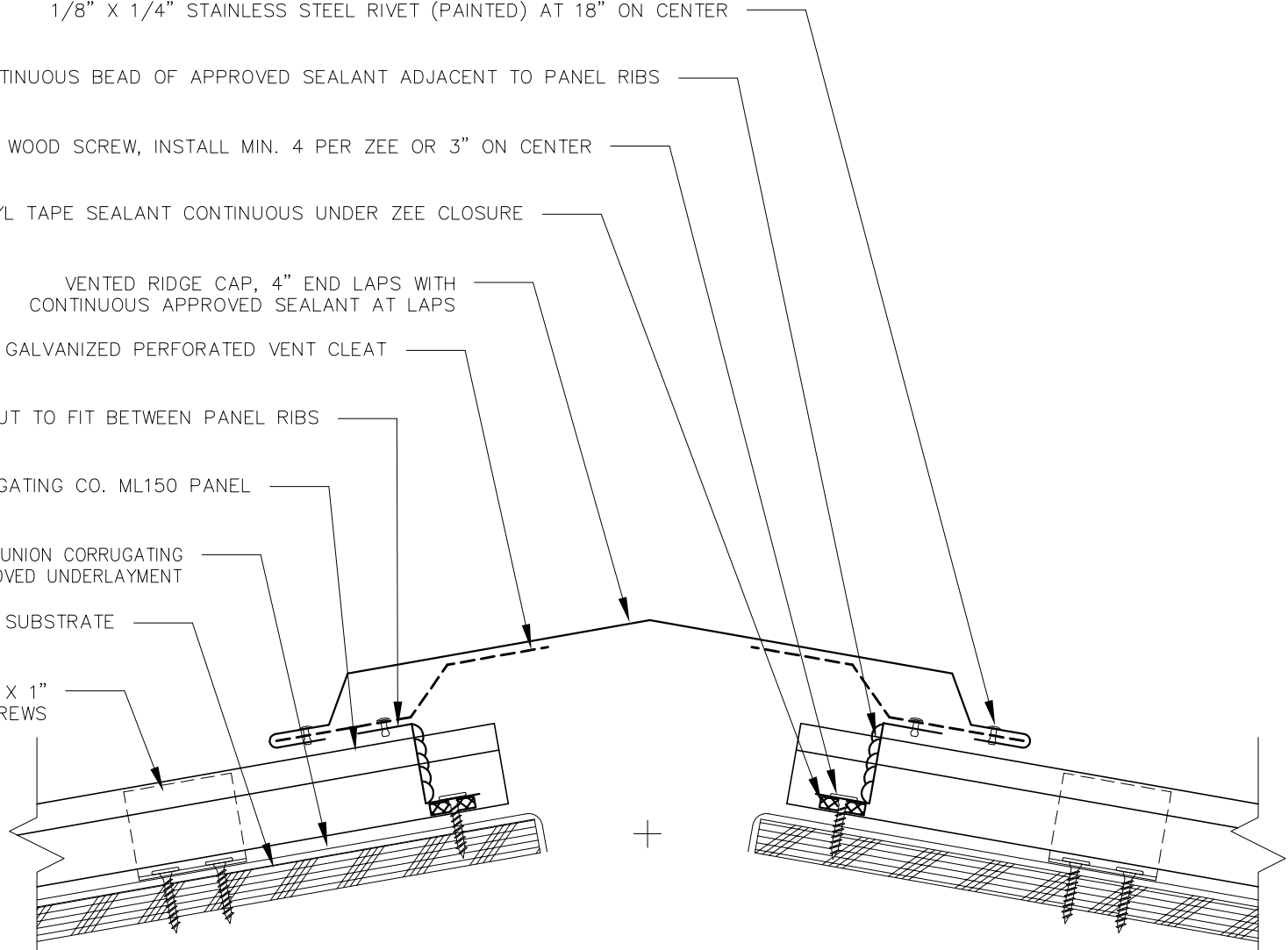

INSTALLATION SEQUENCE:

1. WITH PANELS COMPLETELY INSTALLED OVER SUBSTRATE, LOCATE POSITION OF ZEE CLOSURES AND MARK THE REQUIRED LOCATION
2. FIELD CUT ZEE CLOSURES TO FIT BETWEEN PANEL RIBS AND SET IN CONTINUOUS BEAD OF TAPE SEALANT
3. USE MINIMUM 4 SCREWS PER ZEE CLOSURE OR AT 3" ON CENTER. VERIFY CLOSURE IS FREE OF GAPS OR VOIDS ADJACENT TO PANEL
4. APPLY BEAD OF SEALANT UP EACH SIDE OF ZEE CLOSURE ADJACENT TO PANEL LEGS
5. INSTALL CONTINUOUS SECTIONS OF PERFORATED VENT CLEAT TO TOP OF ZEE CLOSURES WITH RIVETS AT 12" ON CENTER
6. INSTALL HIP OR RIDGE COVER WITH 4" END LAPS AND SEAL AT LAPS. RIVET CAP TO ZEES AT 18" ON CENTER BOTH SIDES



Description:

VENTED RIDGE DETAIL

Detail No.:

ML150-PS-4.40

Substrate:

PLYWOOD SUBSTRATE

Project Name:

Location:

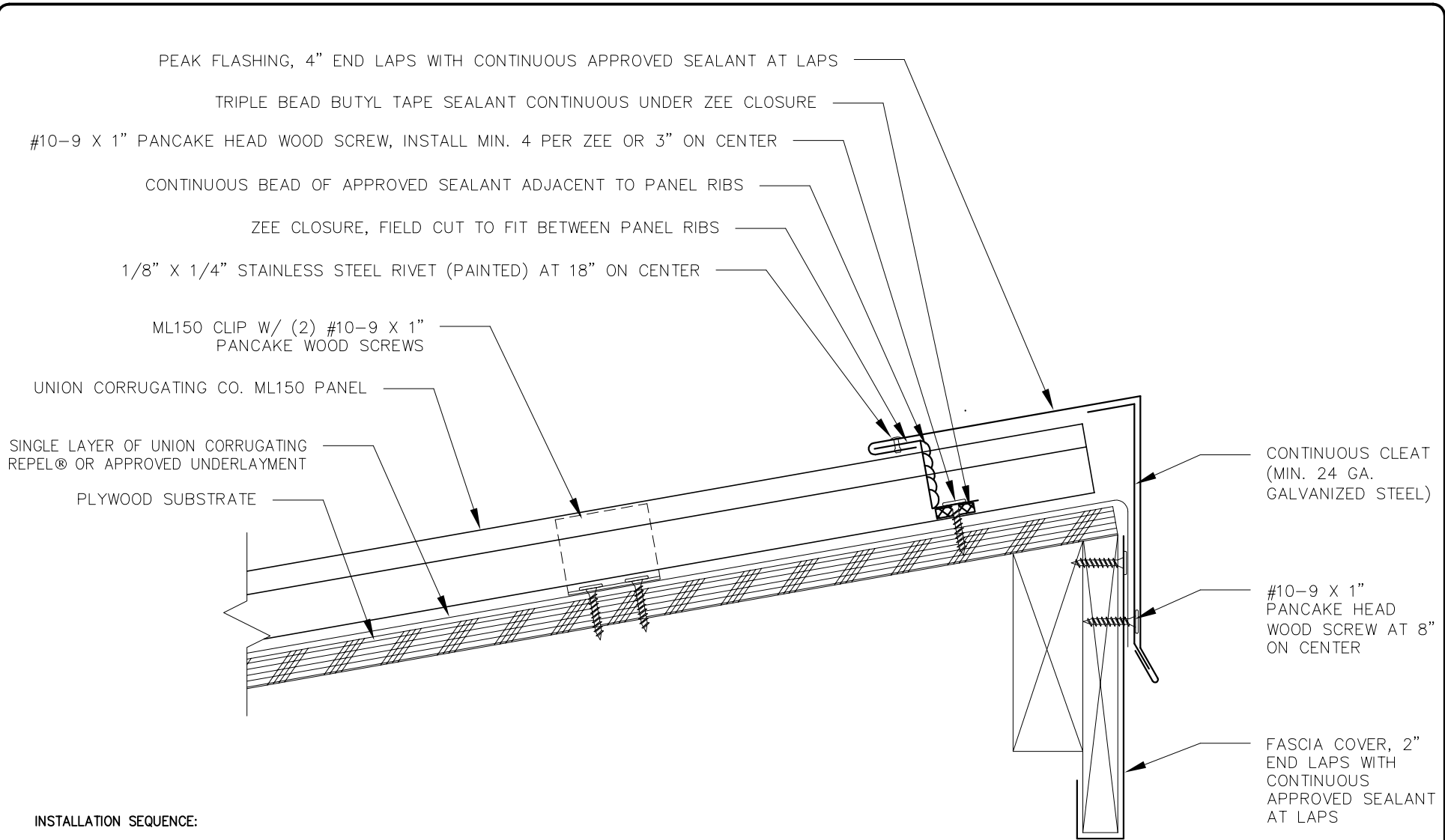

INSTALLATION SEQUENCE:

1. INSTALL FASCIA COVER WITH PANCAKE HEAD WOOD SCREWS AT 12" O.C. MAX.
2. VERIFY LAST COURSE OF UNDERLAYMENT EXTENDS OVER PEAK AND COVERS TOP OF FASCIA TRIM
3. WITH PANELS COMPLETELY INSTALLED OVER SUBSTRATE, LOCATE POSITION OF ZEE CLOSURES AND MARK THE REQUIRED LOCATION
4. FIELD CUT ZEE CLOSURES TO FIT BETWEEN PANEL RIBS AND SET IN CONTINUOUS BEAD OF TAPE SEALANT
5. USE MINIMUM 4 SCREWS PER ZEE CLOSURE OR AT 3" ON CENTER. VERIFY CLOSURE IS FREE OF GAPS OR VOIDS ADJACENT TO PANEL
6. APPLY BEAD OF SEALANT UP EACH SIDE OF ZEE CLOSURE ADJACENT TO PANEL LEGS
7. INSTALL CONTINUOUS CLEAT AT FASCIA WITH PANCAKE HEAD WOOD SCREWS AT 8" ON CENTER MAX.
8. INSTALL PEAK FLASHING WITH 4" END LAPS AND SEAL AT LAPS. RIVET CAP TO ZEES AT 18" ON CENTER



Description:	PEAK DETAIL		Detail No.:
	Substrate: PLYWOOD SUBSTRATE		ML150-PS-5.10
		Project Name:	
		Location:	

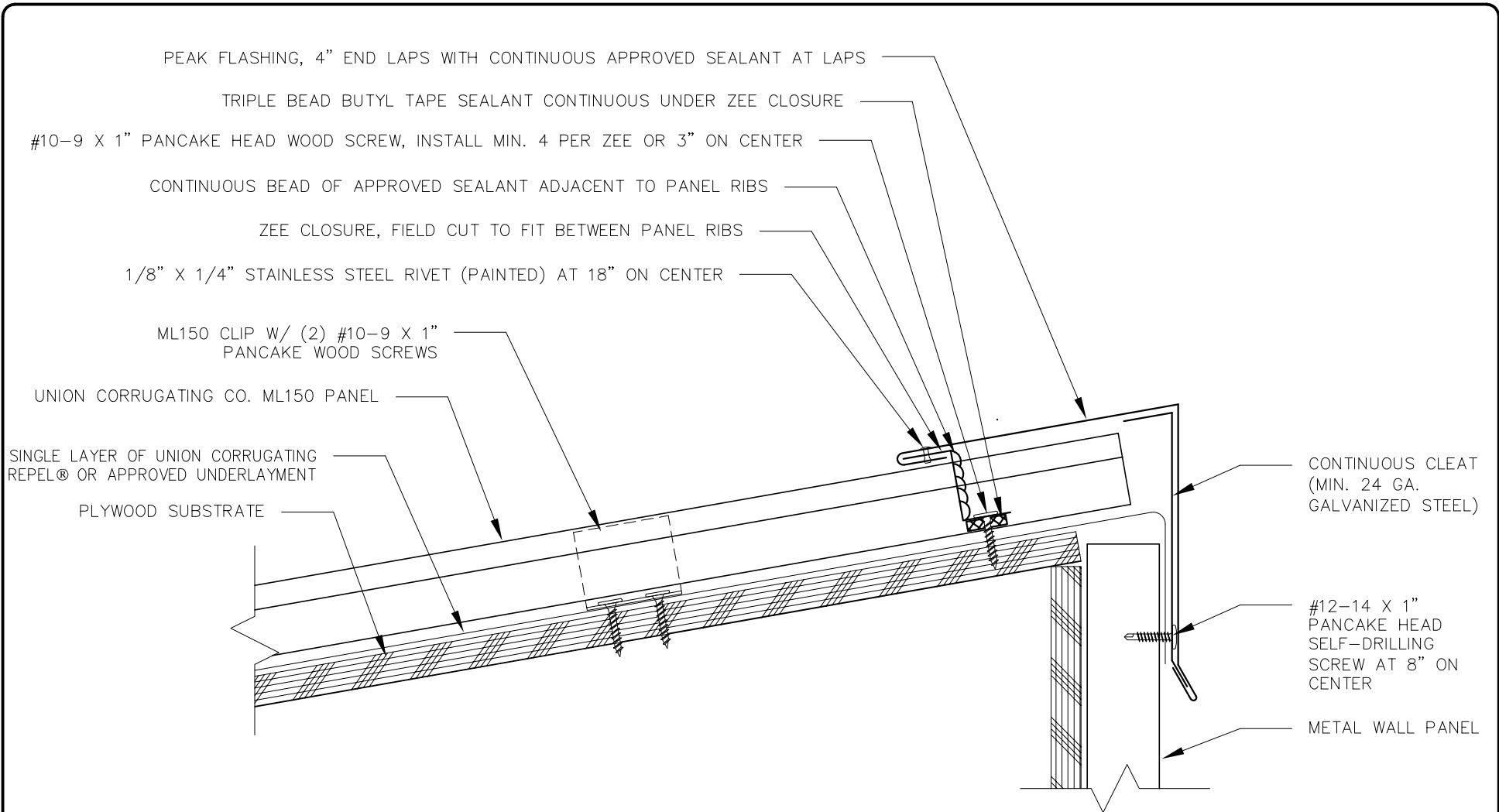

INSTALLATION SEQUENCE:

1. INSTALL WALL PANELS AS REQUIRED
2. VERIFY LAST COURSE OF UNDERLAYMENT EXTENDS OVER PEAK AND COVERS TOP OF WALL PANELS
3. WITH PANELS COMPLETELY INSTALLED OVER SUBSTRATE, LOCATE POSITION OF ZEE CLOSURES AND MARK THE REQUIRED LOCATION
4. FIELD CUT ZEE CLOSURES TO FIT BETWEEN PANEL RIBS AND SET IN CONTINUOUS BEAD OF TAPE SEALANT
5. USE MINIMUM 4 SCREWS PER ZEE CLOSURE OR AT 3" ON CENTER. VERIFY CLOSURE IS FREE OF GAPS OR VOIDS ADJACENT TO PANEL
6. APPLY BEAD OF SEALANT UP EACH SIDE OF ZEE CLOSURE ADJACENT TO PANEL LEGS
7. INSTALL CONTINUOUS CLEAT AT FASCIA WITH PANCAKE HEAD SELF-DRILLING SCREWS AT 8" ON CENTER MAX.
8. INSTALL PEAK FLASHING WITH 4" END LAPS AND SEAL AT LAPS. RIVET CAP TO ZEES AT 18" ON CENTER



Description:

PEAK DETAIL - WITH WALL PANELS

Detail No.:

ML150-PS-5.40

Substrate:

PLYWOOD SUBSTRATE

Project Name:

Location:

CONTINUOUS BEAD OF APPROVED SILICONE SEALANT IN REGLET CUT

REGLET FLASHING, 4" END LAPS WITH CONTINUOUS APPROVED SEALANT AT LAPS

HIGHWALL COUNTER FLASHING, 4" END LAPS WITH CONTINUOUS APPROVED SEALANT AT LAPS

TRIPLE BEAD BUTYL TAPE SEALANT CONTINUOUS UNDER ZEE CLOSURE

#10-9 X 1" PANCAKE HEAD WOOD SCREW, INSTALL MIN. 4 PER ZEE OR 3" ON CENTER

CONTINUOUS BEAD OF APPROVED SEALANT ADJACENT TO PANEL RIBS

ZEE CLOSURE, FIELD CUT TO FIT BETWEEN PANEL RIBS

1/8" X 1/4" STAINLESS STEEL RIVET (PAINTED) AT 18" ON CENTER

ML150 CLIP W/ (2) #10-9 X 1"
PANCAKE WOOD SCREWS

UNION CORRUGATING CO. ML150 PANEL

SINGLE LAYER OF UNION CORRUGATING
REPEL® OR APPROVED UNDERLAYMENT

PLYWOOD SUBSTRATE

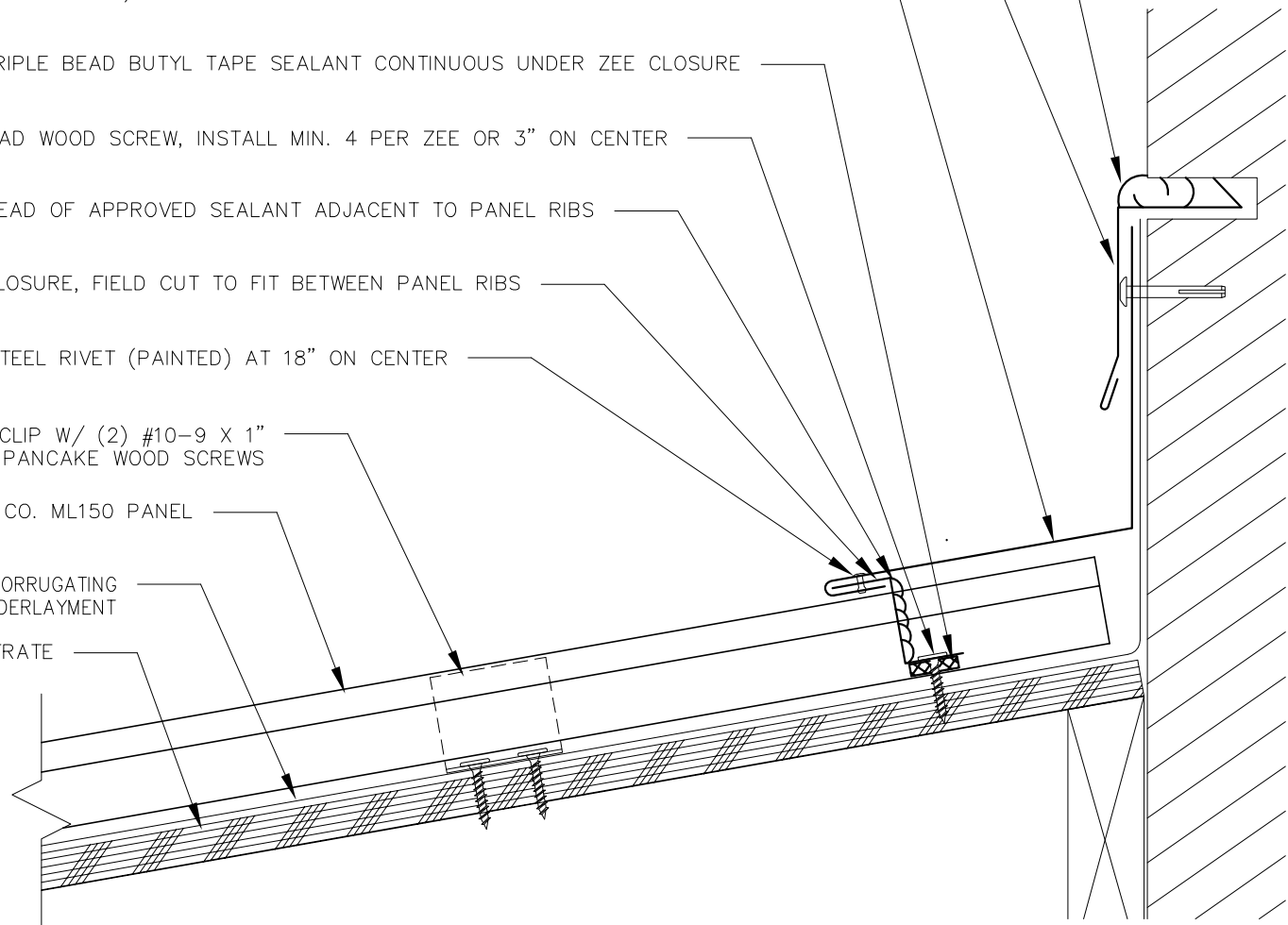

INSTALLATION SEQUENCE:

1. WITH PANELS COMPLETELY INSTALLED OVER SUBSTRATE, LOCATE POSITION OF ZEE CLOSURES AND MARK THE REQUIRED LOCATION
2. FIELD CUT ZEE CLOSURES TO FIT BETWEEN PANEL RIBS AND SET IN CONTINUOUS BEAD OF TAPE SEALANT
3. USE MINIMUM 4 SCREWS PER ZEE CLOSURE OR AT 3" ON CENTER. VERIFY CLOSURE IS FREE OF GAPS OR VOIDS ADJACENT TO PANEL
4. APPLY BEAD OF SEALANT UP EACH SIDE OF ZEE CLOSURE ADJACENT TO PANEL LEGS
5. INSTALL HEADWALL FLASHING WITH 4" END LAPS AND SEAL AT LAPS. RIVET TO ZEES AT 18" ON CENTER
6. INSTALL REGLET FLASHING INTO CUT IN MASONRY AND SEAL CONTINUOUS WITH APPROVED SILICONE SEALANT



Description:

HEADWALL DETAIL - REGLET

Detail No.:

ML150-PS-6.11

Substrate:

PLYWOOD SUBSTRATE

Project Name:

Location:

MEMBRANE ROOFING SYSTEM. EXTEND OVER PARAPET AND DOWN FACE OF WALL MINIMUM 3"

COPING SYSTEM WITH CONTINUOUS CLEAT (MIN. 24 GAUGE) FASTENED AT 8" ON CENTER AT CLEAT AND 12" ON CENTER AT REAR. INSTALL WITH 4" END LAPS WITH CONTINUOUS APPROVED SEALANT AT LAPS.

HIGHWALL COUNTER FLASHING, 4" END LAPS WITH CONTINUOUS APPROVED SEALANT AT LAPS

TRIPLE BEAD BUTYL TAPE SEALANT CONTINUOUS UNDER ZEE CLOSURE

#10-9 X 1" PANCAKE HEAD WOOD SCREW, INSTALL MIN. 4 PER ZEE OR 3" ON CENTER

CONTINUOUS BEAD OF APPROVED SEALANT ADJACENT TO PANEL RIBS

ZEE CLOSURE, FIELD CUT TO FIT BETWEEN PANEL RIBS

1/8" X 1/4" STAINLESS STEEL RIVET (PAINTED) AT 18" ON CENTER

ML150 CLIP W/ (2) #10-9 X 1" PANCAKE WOOD SCREWS

UNION CORRUGATING CO. ML150 PANEL

SINGLE LAYER OF UNION CORRUGATING REPEL® OR APPROVED UNDERLAYMENT

PLYWOOD SUBSTRATE

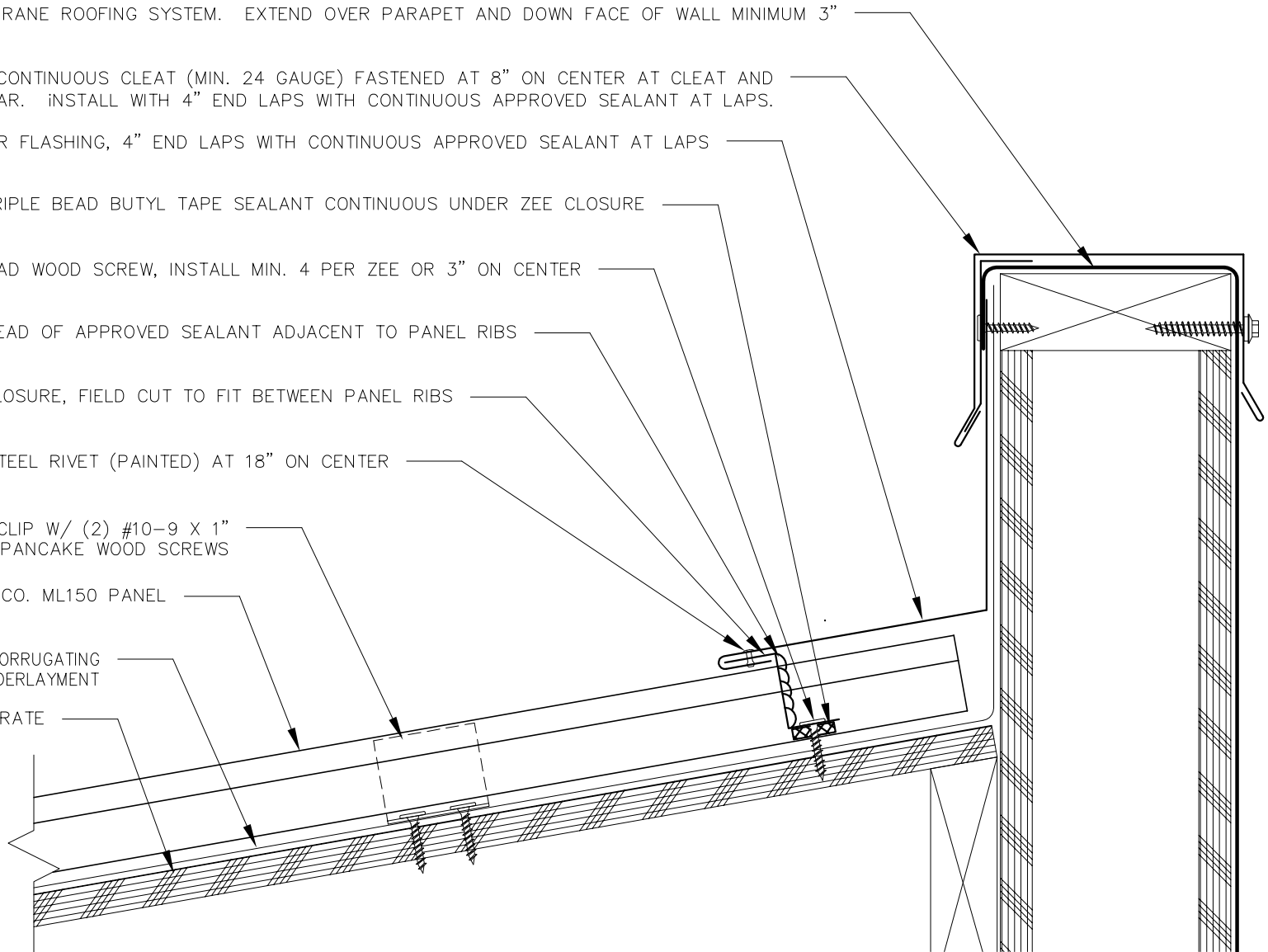

INSTALLATION SEQUENCE:

1. WITH PANELS COMPLETELY INSTALLED OVER SUBSTRATE, LOCATE POSITION OF ZEE CLOSURES AND MARK THE REQUIRED LOCATION
2. FIELD CUT ZEE CLOSURES TO FIT BETWEEN PANEL RIBS AND SET IN CONTINUOUS BEAD OF TAPE SEALANT
3. USE MINIMUM 4 SCREWS PER ZEE CLOSURE OR AT 3" ON CENTER. VERIFY CLOSURE IS FREE OF GAPS OR VOIDS ADJACENT TO PANEL
4. APPLY BEAD OF SEALANT UP EACH SIDE OF ZEE CLOSURE ADJACENT TO PANEL LEGS
5. INSTALL HEADWALL FLASHING WITH 4" END LAPS AND SEAL AT LAPS. RIVET TO ZEES AT 18" ON CENTER
6. INSTALL CONTINUOUS CLEAT AND FASTEN AT 8" ON CENTER. INSTALL COPING CAP WITH 4" END LAPS AND SEAL



Description:

HEADWALL DETAIL - PARAPET COPING

Detail No.:

ML150-PS-6.20

Substrate:

PLYWOOD SUBSTRATE

Project Name:

Location:

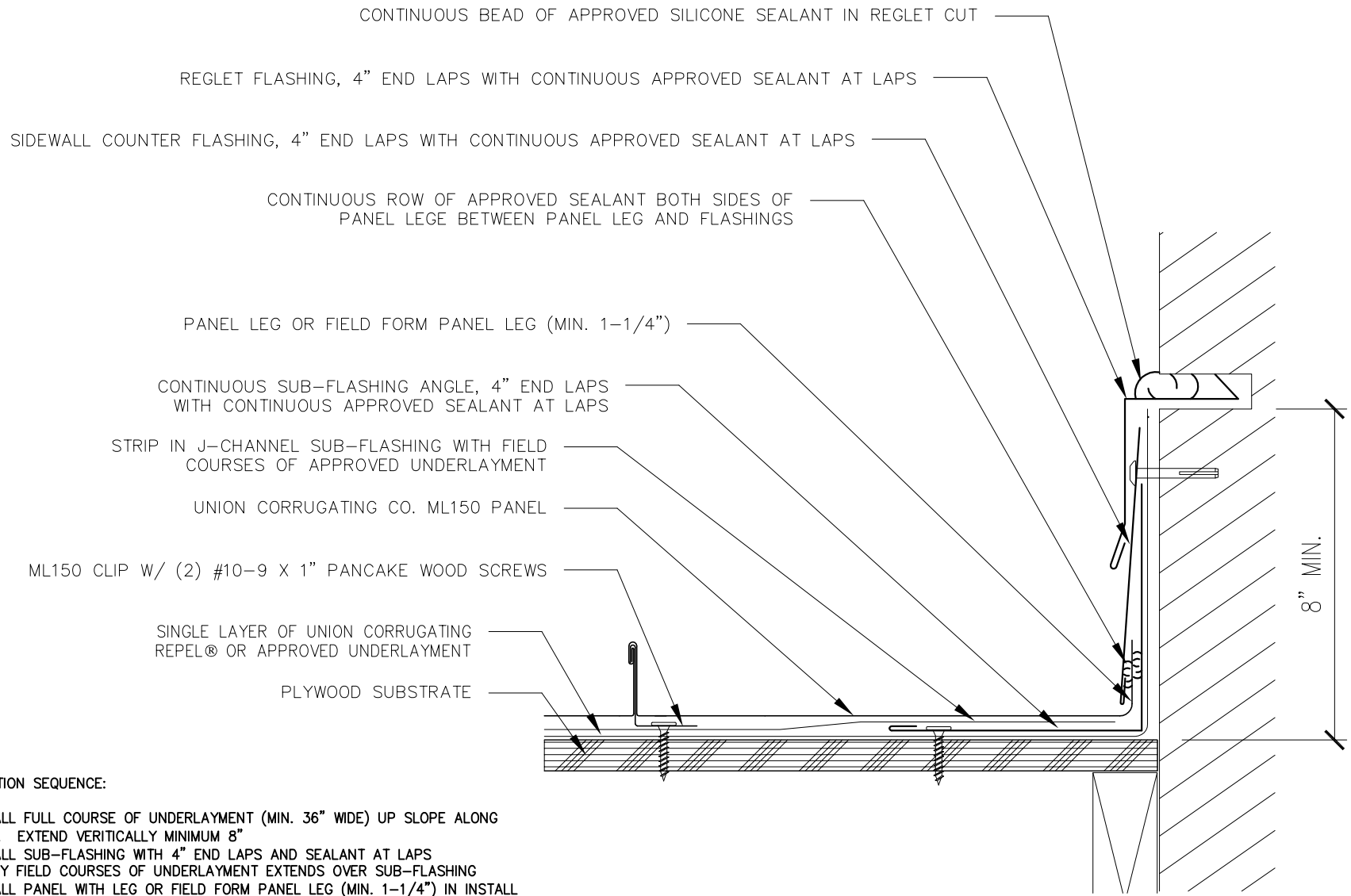

INSTALLATION SEQUENCE:

1. INSTALL FULL COURSE OF UNDERLAYMENT (MIN. 36" WIDE) UP SLOPE ALONG WALL. EXTEND VERTICALLY MINIMUM 8"
2. INSTALL SUB-FLASHING WITH 4" END LAPS AND SEALANT AT LAPS
3. VERIFY FIELD COURSES OF UNDERLAYMENT EXTENDS OVER SUB-FLASHING
4. INSTALL PANEL WITH LEG OR FIELD FORM PANEL LEG (MIN. 1-1/4") IN INSTALL AGAINST SUB-FLASHING SET IN CONTINUOUS BEAD OF SEALANT
5. APPLY CONTINUOUS BEAD OF SEALANT ON EXPOSED PANEL LEG AND INSTALL COUNTER FLASHING WITH 4" END LAPS. CLEAT MAY BE REQUIRED IF COUNTER FLASHING IS OVER 6"
6. INSTALL REGLET COUNTER FLASHING WITH 4" END LAPS AND SEAL WITH APPROVED SILICONE SEALANT



Description:

SIDEWALL DETAIL - REGLET

Detail No.:

ML150-PS-7.11

Substrate:

PLYWOOD SUBSTRATE

Project Name:

Location:

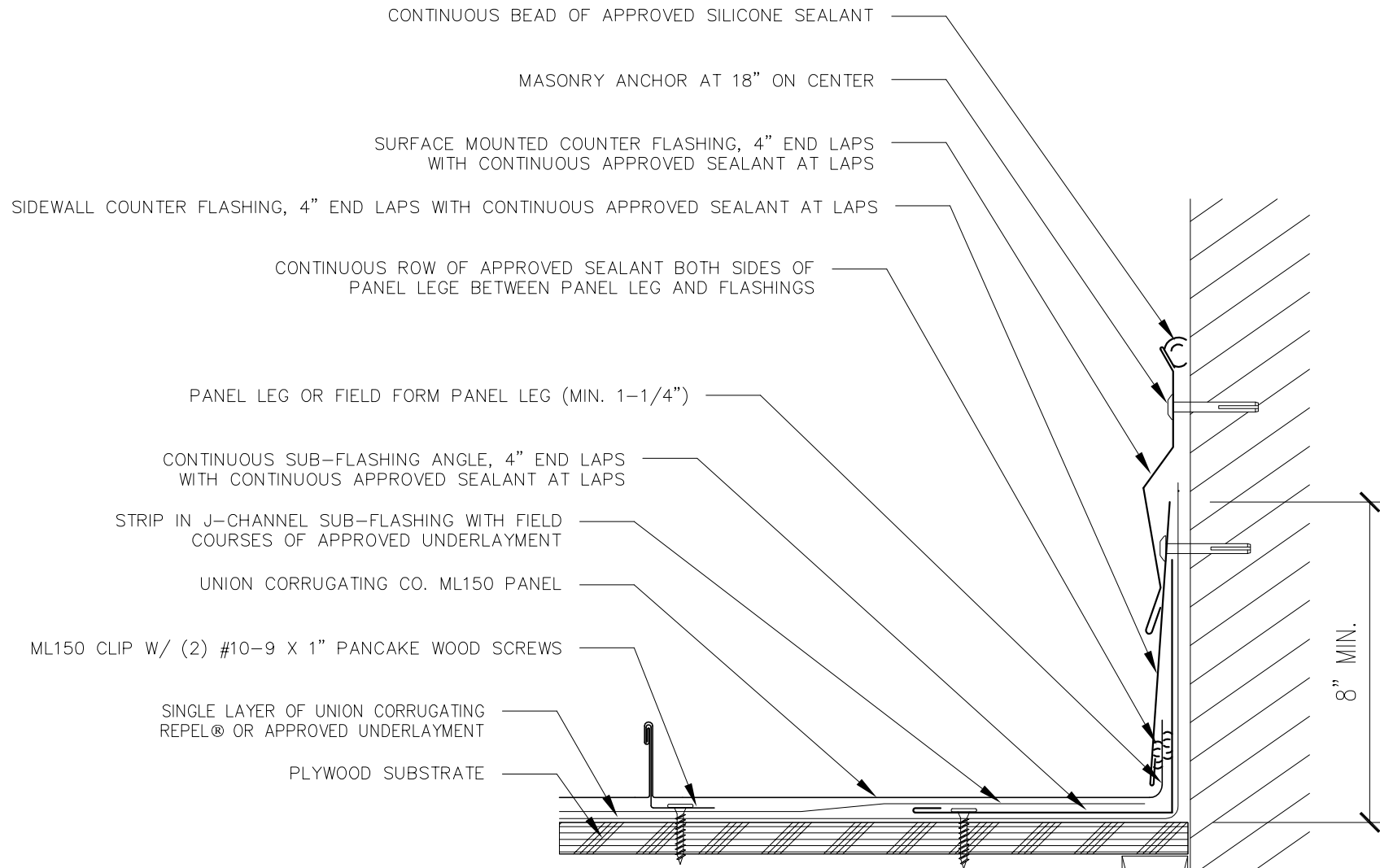

INSTALLATION SEQUENCE:

1. INSTALL FULL COURSE OF UNDERLAYMENT (MIN. 36" WIDE) UP SLOPE ALONG WALL. EXTEND VERTICALLY MINIMUM 8"
2. INSTALL SUB-FLASHING WITH 4" END LAPS AND SEALANT AT LAPS
3. VERIFY FIELD COURSES OF UNDERLAYMENT EXTENDS OVER SUB-FLASHING
4. INSTALL PANEL WITH LEG OR FIELD FORM PANEL LEG (MIN. 1-1/4") IN INSTALL AGAINST SUB-FLASHING SET IN CONTINUOUS BEAD OF SEALANT
5. APPLY CONTINUOUS BEAD OF SEALANT ON EXPOSED PANEL LEG AND INSTALL COUNTER FLASHING WITH 4" END LAPS. CLEAT MAY BE REQUIRED IF COUNTER FLASHING IS OVER 6"
6. INSTALL SURFACE MOUNTED COUNTER FLASHING WITH 4" END LAPS AND SEAL WITH APPROVED SILICONE SEALANT



Description:

SIDEWALL DETAIL - SURFACE MOUNT

Detail No.:

ML150-PS-7.12

Substrate:

PLYWOOD SUBSTRATE

Project Name:

Location:

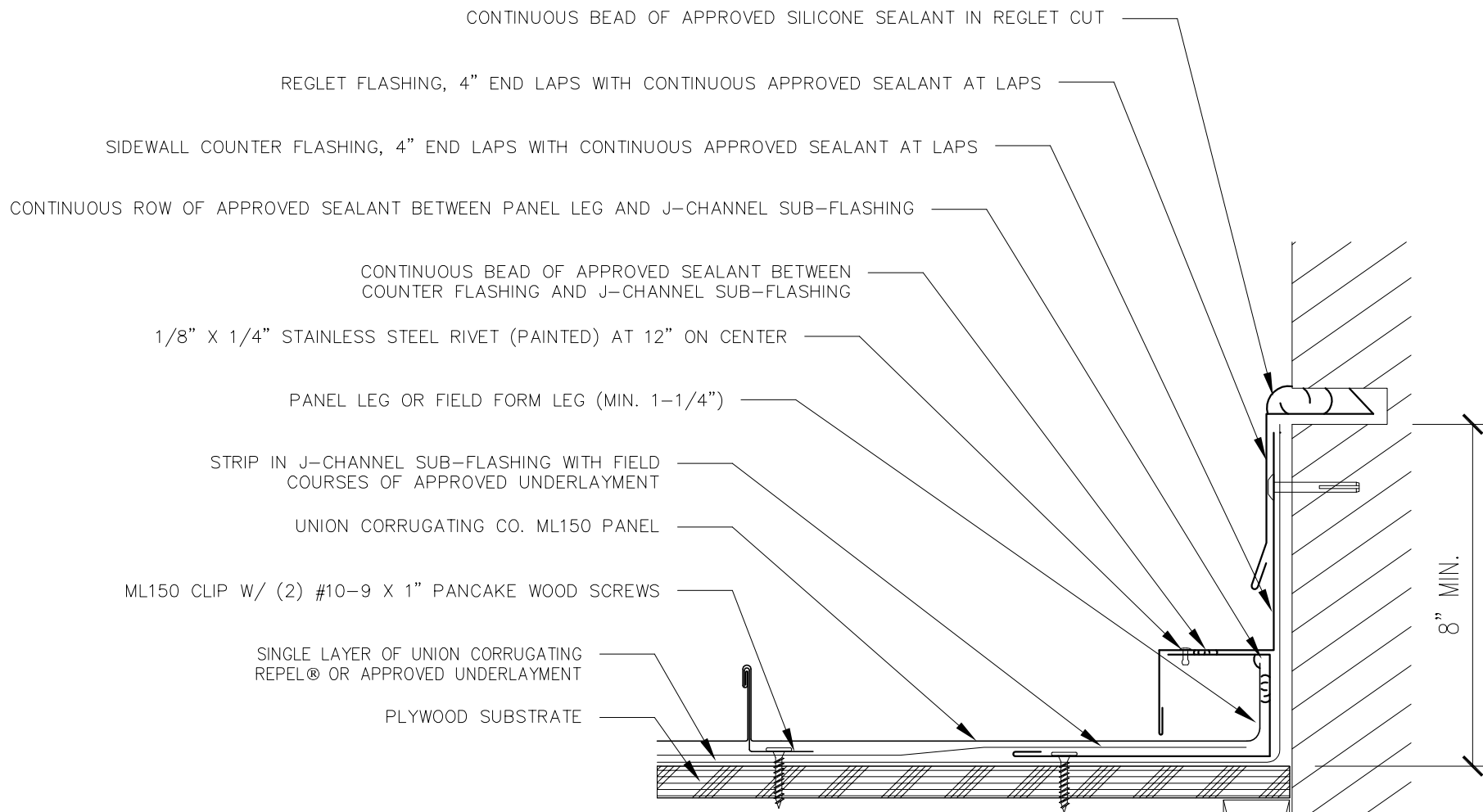

INSTALLATION SEQUENCE:

1. INSTALL FULL COURSE OF UNDERLAYMENT (MIN. 36" WIDE) UP SLOPE ALONG WALL. EXTEND VERTICALLY MINIMUM 8"
2. INSTALL SUB-FLASHING WITH 4" END LAPS AND SEALANT AT LAPS
3. VERIFY FIELD COURSES OF UNDERLAYMENT EXTENDS OVER SUB-FLASHING
4. INSTALL PANEL WITH LEG OR FIELD FORM PANEL LEG (MIN. 1-1/4") IN INSTALL AGAINST SUB-FLASHING SET IN CONTINUOUS BEAD OF SEALANT
5. APPLY CONTINUOUS BEAD OF SEALANT ON EXPOSED PANEL LEG AND INSTALL COUNTER FLASHING WITH 4" END LAPS.
6. INSTALL COUNTER FLASHING WITH REQUIRED MASONRY FASTENER AND RIVET TO J-CHANNEL SUB-FLASHING AT 18" ON CENTER
7. INSTALL REGLET COUNTER FLASHING WITH 4" END LAPS AND SEAL WITH APPROVED SILICONE SEALANT



Description:

SIDEWALL DETAIL - REGLET

Detail No.:

ML150-PS-7.21

Substrate:

PLYWOOD SUBSTRATE

Project Name:

Location:

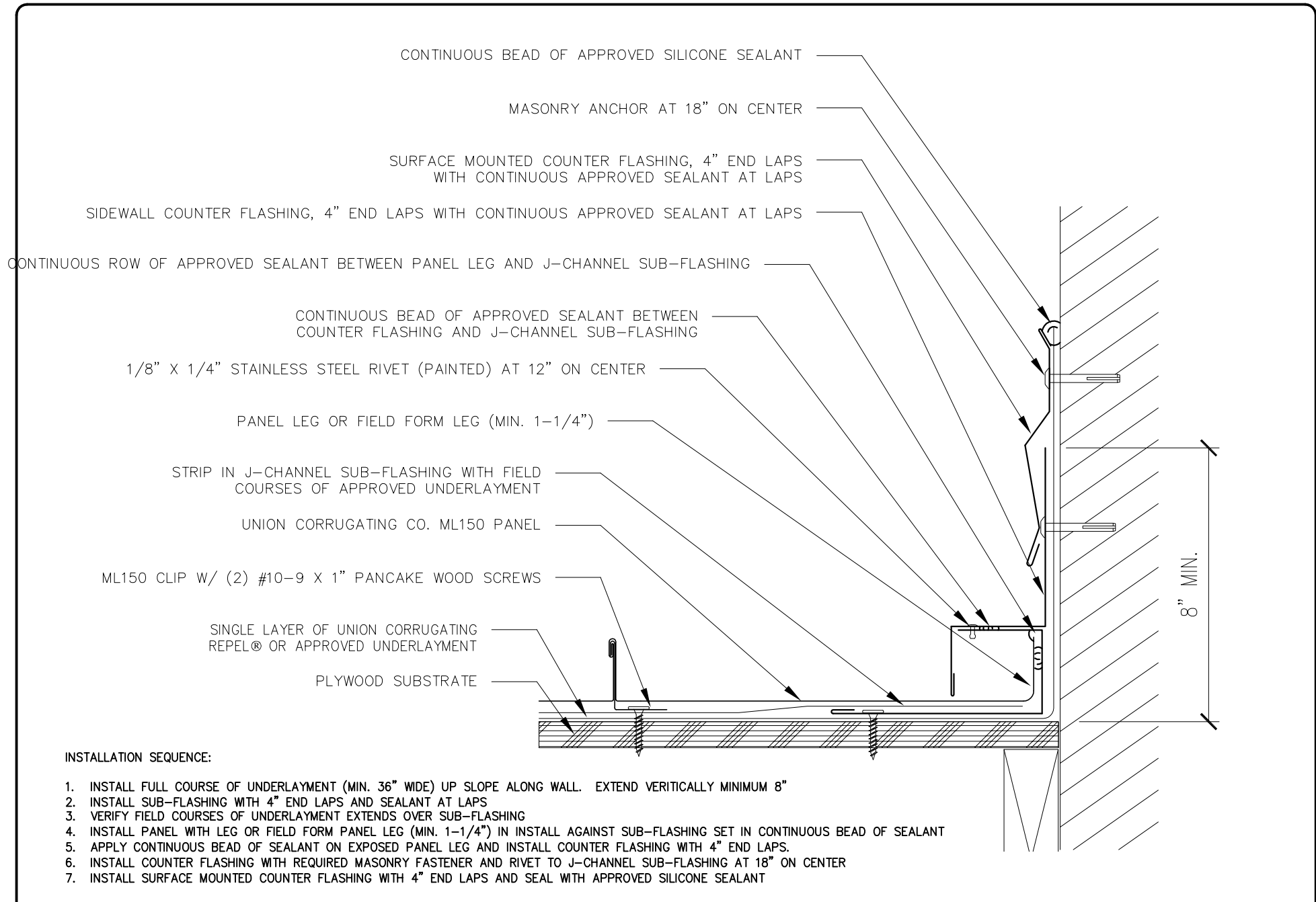

Description:

SIDEWALL DETAIL - SURFACE MOUNT

Detail No.:

ML150-PS-7.22

Substrate:

PLYWOOD SUBSTRATE

Project Name:

Location: